

NTS-6001 INSTALLATION AND CONFIGURATION MANUAL



CONTENTS

Contents.....	2
Introduction	4
Features	4
What should be shipped	5
Standard Parts.....	5
Optional Parts	5
Technical Specification.....	6
System Overview	7
NTS-6001.....	7
GPS Antenna	8
MSF Antenna.....	9
DCF Antenna	10
WWVB Antenna	11
Wiring the unit	12
GPS.....	12
Extending the antenna with Cat5e/Cat6 Cable.....	12
Extending the antenna with eight - Core Cable	13
Radio – MSF/DCF/WWVB	14
Extending the antenna with Cat5e/Cat6 Cable.....	14
Extending the antenna with four - Core Cable	15
Setting up the Unit.....	16
Connecting everything up.....	16
Server Location	16
Connect to Network.....	16
Install Antenna	16
Connecting the Server to the Antenna	16
Configuration	17
Troubleshooting.....	18

Technical Support	19
Setting the IP Address Manually	19
Debug the Unit	20
GPS	20
Radio	21
Resetting the Bios	22
Support Website	23
Warranty and Maintenance	25
Warranty	25
Technical Support, Repair and Returns	25



INTRODUCTION

The NTS-6001 is a rack-mount time server based on an embedded Linux operating system and is designed to serve as a time source for medium to large companies. The rack-mount unit combines the ability to synchronise time across networks and peer multiple time servers with the stability of a dedicated operating system to provide a stable and reliable time source.

FEATURES

- Easy to install and setup – it can be out of the box and working within a short space of time, fully configurable via the web browser, no knowledge of Linux required.
- For security, the unit is locked down, all unnecessary services are disabled and the unit utilises HTTPS and SSL to protect passwords.
- Support for GPS and radio based synchronisation for redundancy.
- Supports over 10,000 NTP requests per minute.
- Dual Ethernet interface allows for redundancy or can be used to keep the public and private networks separate.
- Full support for MD5 based authentication and peering with other NTP servers.
- Upgradable flash memory allows for a unit in a locked down environments to receive software updates.
- Front panel display showing antenna status and system information.



WHAT SHOULD BE SHIPPED

STANDARD PARTS

- NTS-6001 rack-mount unit
- IEC power cable
- GPS or MSF or DCF or WWVB antenna *
- Junction Box and IDC Cable Tool
- Mounting bracket and fixing for antenna
- CD containing manual and software

OPTIONAL PARTS

- Light Arrestor(s)
- Cable for extending the antenna(s)
- Gold and Premium Support
- Digital Wall Clock - Ethernet Powered
- Secondary Time Source Available - GPS Units only
- Antenna Cable - Available from 100 to 1,000 metre rolls
- Additional Power Supply - Recommended from 550 metres onwards

* The antennas provided will depend on which has been ordered, however, all units come with at least one antenna

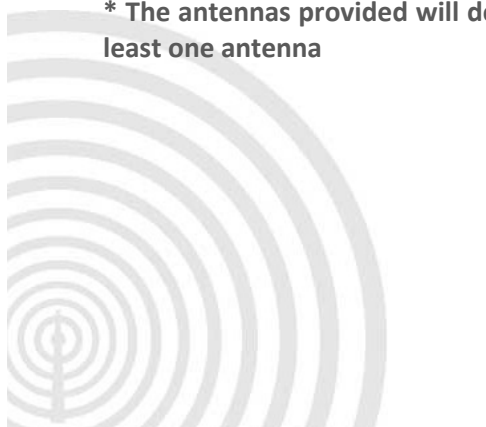

TECHNICAL SPECIFICATION

Protocols - NTP & SNTP	NTP v2 (RFC 1119) NTP v3 (RFC 1305) NTP v4 (RFC 2131) SNTP v3 (RFC 1769) SNTP v4 (RFC 2030)
Configuration	Across a Network via Secure Browser
Configuring	https (RFC 2616) Secure Shell (SSH)
Technical Standard	NEMA 0183 V.2 Compliant
SNMP	Simple Network Management Protocol (Can Be Switched ON)
Network Interface	Standard 10/1000 Base-T, Dual RJ-45 Network Connections
MTBF Estimated	45,000 hrs.
Display	LCD with Backlight
Operating System	Linux Based
Operating Temperatures	0-50°C (32-122°F)
Heat Dissipation	150 BTU Per hour
Humidity	Max. 85% Non-Condensing
Mount	Rack
Function	Stratum 1 Time Server, Secure Shell (SSH) and HTTPS
Network Accuracy	Network: 1-10 Milliseconds, Typical GPS/Radio: <1 Microseconds, Relative to UTC
Security	MD5 Authentication
NTP Time Requests	Up To 4700 Per Sec
Power Supply Universal	85-260V, 47-63Hz
Power Consumption	27 Watts
Dimensions (mm) Packed Unpacked	Packed Up: (H) 160 (W) 620 (D) 630 Unpacked 1U: (H) 45 (W) 425 (D) 309
Properties	Powder Coated Steel
Weight Packed Unpacked with Antenna	7.6kg 4.8kg
Source	Satellite Radio
External	Active 12 Channel GPS MSF/DCF/WWVB Antenna



SYSTEM OVERVIEW

NTS-6001

The Galleon NTS-6001 network time server synchronises network time and provides a reliable stratum 1 response with 282,000 time requests per minute. With easy plug-and-play installation and equipped with 2 Ethernet ports for network interfacing, the NTS-6001-GPS can also peer connect for advanced security.

The IP address can either be automatically configured by DHCP or a static IP address can be entered manually. The front panel is equipped with a backlit LCD screen and displays run-time information for the NTP subsystem.

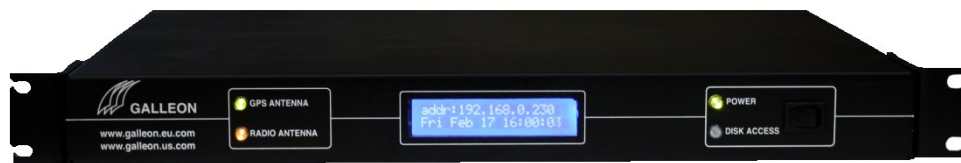

GPS ANTENNA

Tracking up to 12 satellites at the same time, GPS offers an accurate signal capable of a reliable and consistent reading anywhere in the world. Used extensively for synchronising time from one location to another, GPS signals are received globally and maintain a high level of accuracy.

Functional up to 1000m (3,000 ft.) away from the time server, additional cable length can be added to the supplied 10m to increase cable size to desired length. An extra power supply is recommended past the length of 550m to ensure the unit is running at optimum efficiency.

The GPS antenna is encased in a weatherproof IP65 enclosure and should be mounted on the roof of a building with a 180-degree view of the sky.

The antenna can be mounted to the side of the building; however, limiting the view of the sky will have an effect on the units' ability to synchronise. Units mounted to the side of the building will experience short periods of time where the antenna is unable to see the three satellites required to achieve synchronisation.

Some things to avoid are older computer monitors, switch mode power supplies and air conditioning units.

The GPS antenna uses eight-core signal cable and will function on a cable run of up to 550 metres drawing power from the rack-mount unit, if you require the antenna to have an extended cable run of up to 1,000 metres then a power supply is required. This power supply feeds directly into the GPS antenna and as such, would need to be located on the roof too. In most cases however, 550 metres is more than adequate.

The Operating temperature for the antenna is -40 Celsius to +85 Celsius so it may be worth noting that the temperature inside the enclosure can be considerably different from the external temperature, especially when the antenna is located in a position where it is in direct sunlight.

When mounting a GPS antenna it may be worth noting that satellites dishes can have a negative effect on the unit, it's best to keep the GPS antenna at least ten metres from them.



MSF ANTENNA

The MSF signal is broadcast from Anthorn in Cumbria and is maintained at a reliable frequency of 60 kHz, delivering a steady signal undisrupted by changing weather conditions and operational 24 hours a day. The radio signal is designed to cover the whole of the United Kingdom.

Functional up to 1000m (3,000 ft.) away from the time server, additional cable length can be added to the supplied 10m, to increase cable size to the desired length. An extra power supply is recommended past the length of 550m to ensure the unit is running at optimum efficiency.

One thing to bear in mind with a radio-based antenna is that certain electrical equipment generates noise on the same frequency as the radio signal and can cause interference. Some things to avoid are older computer monitors, switch mode power supplies and air conditioning units.

Radio based antennas are also directional antennas. The front of the antenna (this is the opposite side to where the cable enters the weatherproof box) should be facing the transmitter for the best signal reception.

For more information on the MSF signal, including information on scheduled maintenance times please refer to the National Physics Laboratory's website at www.npl.co.uk



DCF ANTENNA

The DCF antenna receives a radio signal broadcast at 77.5 kHz from Frankfurt (Main). The signal covers the whole of Germany and impressively most of Europe too.

Functional up to 1000m (3,000 ft.) away from the time server, additional cable length can be added to the supplied 10m to increase cable size to the desired length. An extra power supply is recommended past the length of 550m to ensure the unit is running at optimum efficiency.

One thing to bear in mind with a radio-based antenna is that certain electrical equipment generates noise on the same frequency as the radio signal and can cause interference. Some things to avoid are older computer monitors, switch mode power supplies and air conditioning units.

Radio based antennas are also directional antennas. The front of the antenna (this is the opposite side to where the cable enters the box) should be facing the transmitter for the best signal reception.

For more information on the DCF signal including information on scheduled maintenance times, please refer to the Physikalisch-Technische Bundesanstalt website at www.ptb.de English can be selected via the menu located at the top left side of the site.

There is an alternative website for information on the DCF signal, however, please note this website is provided only in German at www.dcf77.de



WWVB ANTENNA

The WWVB antenna receives a radio signal broadcast at 60 kHz from two transmitters near Fort Collins in Colorado. One benefit of using the WWVB signal is that as they have two transmitters that have different scheduled down times, the WWVB signal is not affected by maintenance.

Functional up to 1000m (3,000 ft.) away from the time server, additional cable length can be added to the supplied 10m, to increase cable size to the desired length. An extra power supply is recommended past the length of 550m to ensure the unit is running at optimum efficiency.

One thing to bear in mind with a radio-based antenna is that certain electrical equipment generates noise on the same frequency as the radio signal and can cause interference. Some things to avoid are older computer monitors, switch mode power supplies and air conditioning units.

Radio based antennas are also directional antennas. The front of the antenna (this is the opposite side to where the cable enters the box) should be facing the transmitter for the best signal reception.

For more information on the WWVB signal please refer to the National Institute of Standards and Technology (NIST) under the Time and Frequency Division at www.nist.gov/pml/div688/grp40/wwvb.cfm



WIRING THE UNIT

GPS

Extending the antenna with Cat5e/Cat6 Cable

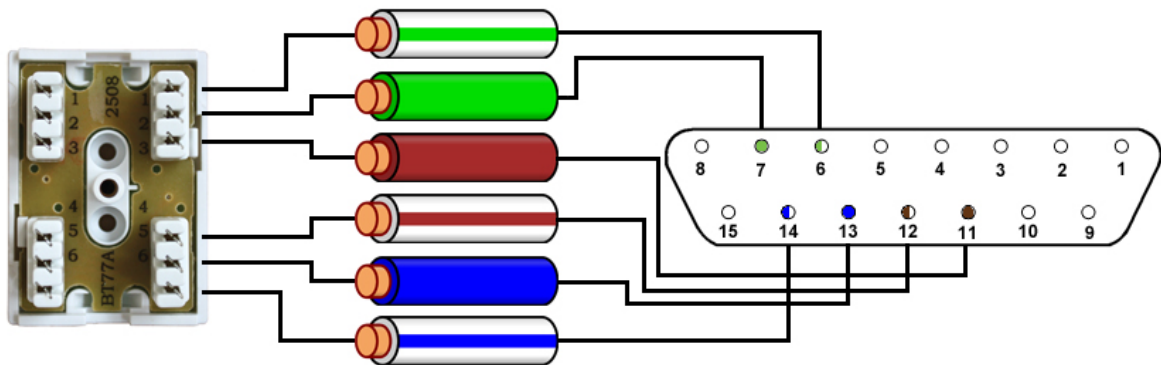

15 Way D-Type Pin	Cable Colour
6	Green/White
7	Green
11	Brown
12	Brown/White
13	Blue
14	Blue/White

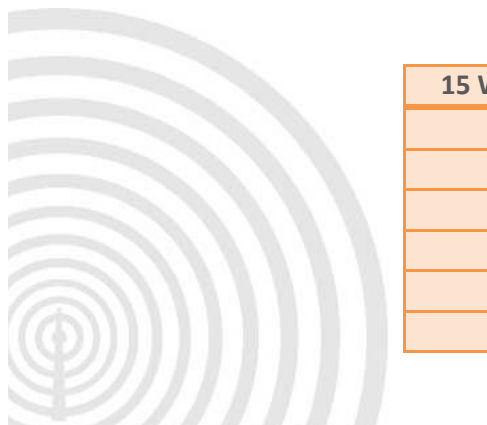

Extending the antenna with eight - Core Cable

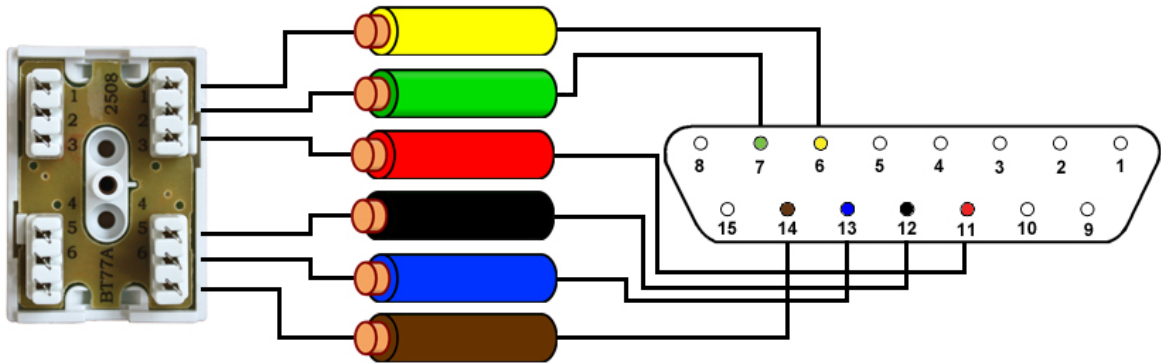

15 Way D-Type Pin	Cable Colour
6	Yellow
7	Green
11	Red
12	Black
13	Blue
14	Brown

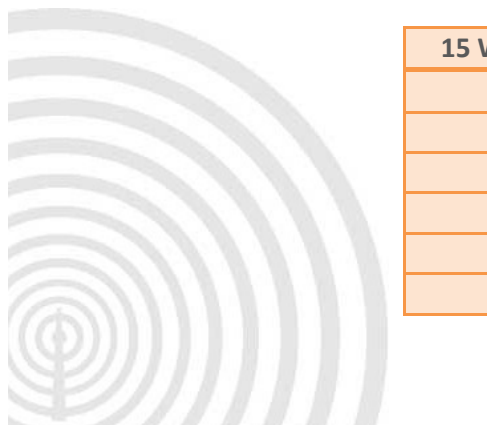

RADIO – MSF/DCF/WWVB

Extending the antenna with Cat5e/Cat6 Cable

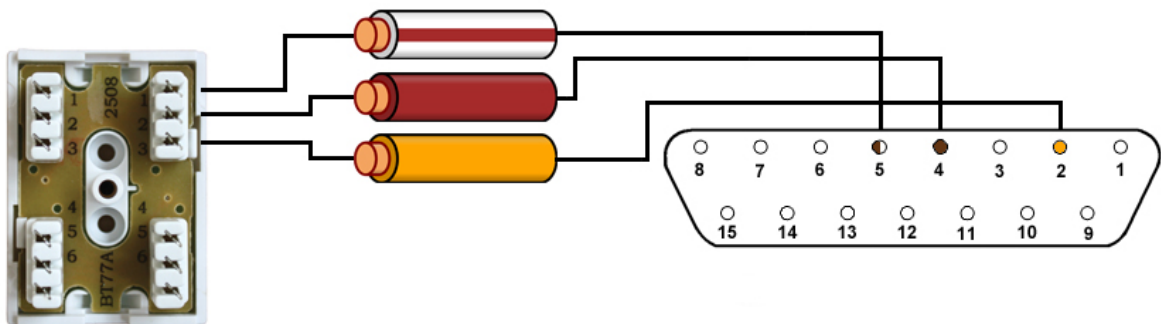
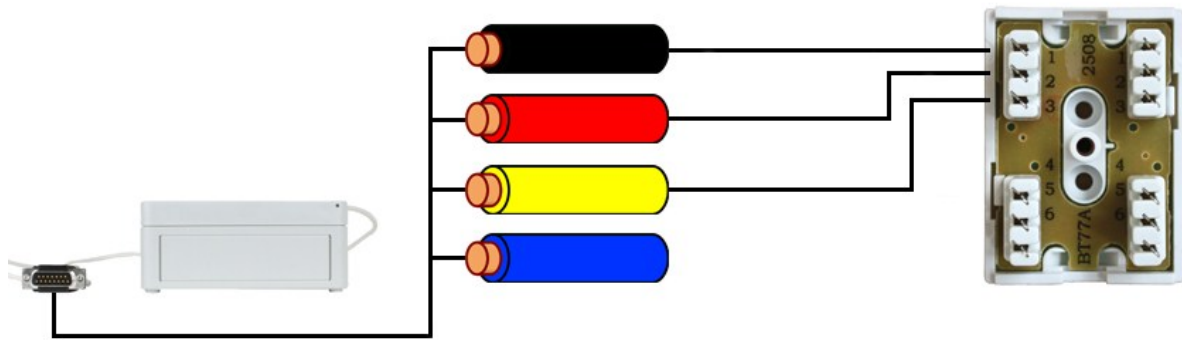

15 Way D-Type Pin	Cable Colour
2	Orange
4	Brown
5	Brown/White

Extending the antenna with four - Core Cable

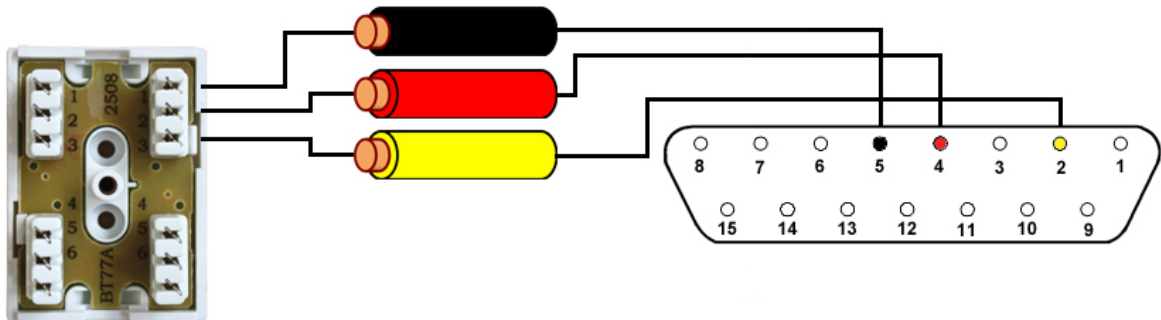
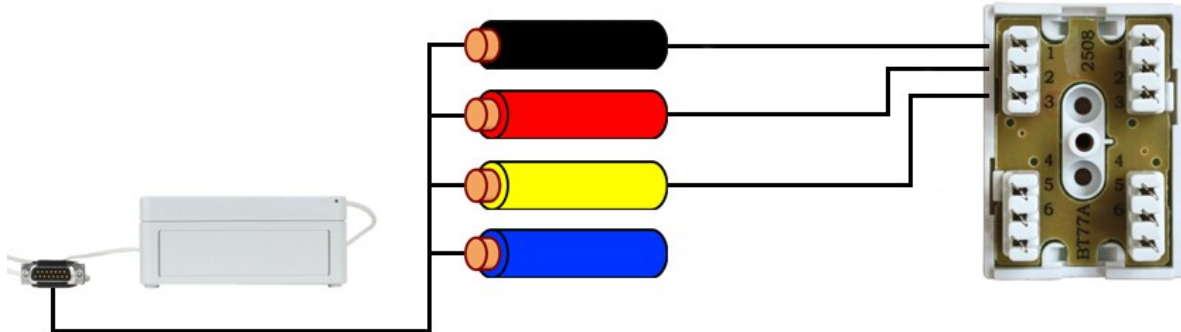

15 Way D-Type Pin	Cable Colour
2	Yellow
4	Red
5	Black



SETTING UP THE UNIT

CONNECTING EVERYTHING UP

Server Location

Choose a suitable location for the NTS-6001; please bear in mind you will need to run a cable from this location preferably to the roof of the building or to a window.

Connect to Network

Connect the NTS-6001 to the network using a standard RJ-45 cable. If your network supports DHCP then the unit will automatically obtain an IP Address. If you require the unit to be used across another network then you can connect the second port to the network using a standard RJ-45 cable in the same manner as the first.

Install Antenna

Choose an area to mount the GPS/Radio Antenna; the ideal place would be the roof of the building with a clear view of the sky (GPS) or facing the correct Transmitter (Radio). Things to avoid are air conditioning units and power distribution units, as these will cause electrical interference.

Please note that if you are extending the cable to a length of 550m or greater, then you will need an extra power source, located either on the roof or can be accessed from the roof.

Connecting the Server to the Antenna

The cable should be run from the rack mount enclosure to the selected mounting position.

Please note that it is a good idea to leave some slack cable in case you need to move the unit later. Also the maximum cable length should not exceed 1000m.

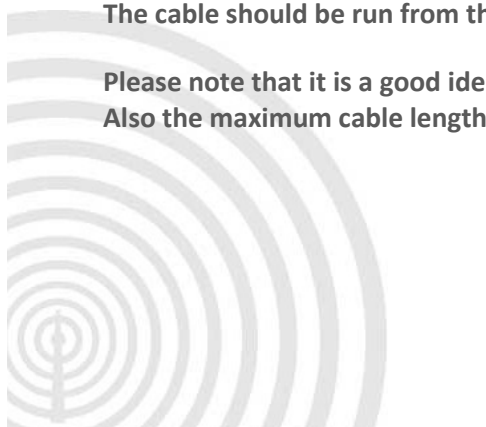

CONFIGURATION

Once everything is connected up, the NTS-6001 can then be powered up. The unit will start up and begin running the necessary processes. The LCD display will start and show the following:

- LCD INITIALISED
- ASMINT DISPON 20M

Next the unit will check for data coming into the serial connector:

- WAITING SERIAL DATA

The unit will display the current software version:

- Software Version 10

A time and date will then be displayed:

- Fri Jul 15 13:54:59

And the unit will seek to synchronise with either GPS or Radio:

- Waiting for 1st sync
- Fri Jul 15 13:56:30

During the waiting period for synchronisation, the Unit will remain in an 'unsynchronised state':

- NTP Unsynchronised
- Fri Jul 15 13:57:19

The unit will show that it 'knows' there is an antenna attached:

- GPS Antenna OK
- Fri Jul 15 13:58:31

Once in a 'synchronised state' the unit will display:

- NTP Synchronised
- Fri Jul 15 13:59:58

In this state, the display will show the GPS/Radio information as well as the date and time

At all times, the unit will display the IP Address in the message cycle.

TROUBLESHOOTING

Use this section to quickly troubleshoot minor issues or common problems.

For any further support, please contact us using our Support Website, which can be found at:

galleonsupport.com

Q) What do the LED's on the front of the unit indicate?

A) On the front of the unit there are 4 lights and an on/off switch. The green 'Power' light indicates that there is power to the unit. The blue 'Disc Access' light only flashes on when you boot the unit up, after that it should remain off at all times. The green 'GPS Antenna' light will flash when the unit is picking up the signal from the antenna. The yellow 'Radio Antenna' light will flash when the unit is picking up the signal from the antenna. Both the green 'GPS Antenna' light and the yellow 'Radio Antenna' lights will flash when the unit is picking up the signal from both the antennas.

Q) On the LCD display the time on my rack-mount appears to be incorrect, however the unit is synchronised.

A) The rack-mount unit uses UTC (Coordinated Universal Time). This is time without time-zones or daylight savings. Time-zones and daylight saving time needs to be applied to the clients on your network.

Q) What is the login for the unit?

A) To log into the unit you need to go to a web browser and type in 'http://' followed by the IP Address of the unit and you will be presented with the User Interface.

Username: admin

Password: password

Q) How do you peer two or more NTS-6001's?

A) Log into the unit using the web browser and click on NTP customisation on the sidebar. Type in the text area the word 'server' with a space followed by the IP Address of the unit you would like to peer, example: "server 192.168.0.20" click okay and then click save settings to flash and then reboot the unit and they will be peered. This can be done for as many units as you want.

Q) I forgot my password how can I reset?

A) It is strongly advised that you don't forget your password, but if in the eventuality that you do forget your password, you will need to talk to the Technical Support team to resolve the issue.

TECHNICAL SUPPORT

SETTING THE IP ADDRESS MANUALLY

If you are required to set the IP Address of the NTS-6001 manually, then first you must plug a standard USB keyboard into the unit before turning on the NTS-6001 unit. Once the unit is on please use the following steps to set the IP Address manually.

Type D

Press Enter

Set the Edit DHCP to N

Press Enter

Type S to save

Type I to Edit IP Address

Press Enter

Type in new IP Address (xxx.xxx.xxx.xxx)

Press Enter

Type S to save

Type M to Edit Subnet Mask

Type in the Subnet Mask (255.255.255.xxx)

Press Enter

Type S to save

Type G to Edit Gateway

Type in the Gateway (usually 192.168.0.1)

Press Enter

Type S to save

Reboot the System

DEBUG THE UNIT

GPS

Debugging the NTS-6001 GPS (for advanced users)

Log-in to the web admin page. The default username is "admin", and the default password is "password". Then go to "Configure SSH Access" and enable SSH.

To connect via SSH using putty (download link below) the default username is "root" and the default password is "galleon".

Press "q" followed by enter to break out of the menu system.

Now stop the GPS service using the command below:

Note: In the command below the single speech marks are "Acute" on an English keyboard they are generated by using the key above tab (failing that copy and paste the command).

```
kill `pidof gpsclkd`
```

And restart the service using the following command:

```
gpsclkd -d /dev/clk
```

You should see debug information like this if the GPS is synchronised:

```
clock elapsed-pc elapsed=-0.000000
```

```
shm: storing time 1310372187.000000 local 1310372186.999965 err 0.000001 leap 0
```

```
Receiving $GPRMC data 2011/7/11 08:16:27 UTC Synchronised
```

If you receive nothing check the cabling, or if the Receiving line says the unit is Un-synchronised check the GPS has a good view of the sky (we recommend 180 degree view of the sky)

Note: When you have the antenna working break out of the debug with "ctrl + c" and then reboot the unit using the command "reboot".

Putty Download Link:

<http://the.earth.li/~sgtatham/putty/latest/x86/putty.exe>



Radio

Debugging the NTS-6001 Radio (for advanced users)

Log-in to the web admin page. The default username is "admin", and the default password is "password". Then go to "Configure SSH Access" and enable SSH.

To connect via SSH using putty (download link below) the default username is "root" and the default password is "galleon".

Press "q" followed by enter to break out of the menu system.

Now stop the MSF service using the command below:

Note: In the command below the single speech marks are "Acute" on an English keyboard they are generated by using the key above tab (failing that copy and paste the command).

```
kill `pidof radioclkd`
```

And restart the service using the following command:

```
radioclkd -t clk
```

You should see debug information like this if the MSF is synchronised:

```
DCD: 1 0 1668
```

```
DCD: 1 0 1668
```

```
DCD: 1 0 1668
```

If you receive nothing check the cabling, correct reception should be one message per second.

Note: When you have the antenna working break out of the debug with "ctrl + c" and then reboot the unit using the command "reboot".

Putty Download Link:

<http://the.earth.li/~sgtatham/putty/latest/x86/putty.exe>



RESETTING THE BIOS

Resetting the NTS-6001 BIOS

Boot the unit with a monitor and keyboard attached and hit the num pad delete key repeatedly to get to the bios.

In the bios go to the [EXIT] tab and then to “Load failsafe defaults” and hit [OK] in the confirm dialogue box.

Then go to the [ADVANCED] tab and select “Super IO Configuration” from here you want to change the following:

Note: Make a note of what these settings are on before you change them as it will help with debugging the unit.

Serial Port 1 IRQ from 11 to 4

Serial Port 2 IRQ from 10 to 3

Then press [F10] to save and exit and [OK] in the confirm dialogue box.



SUPPORT WEBSITE

Should you require any Technical Support on this product, please go to galleonsupport.com where you can find access to the Knowledgebase, for general information.

For any further questions please submit a ticket detailing the problems or technical issues you are having, and a member of the Technical Support Team will be available to support you. When submitting a ticket, please give as much information as possible.

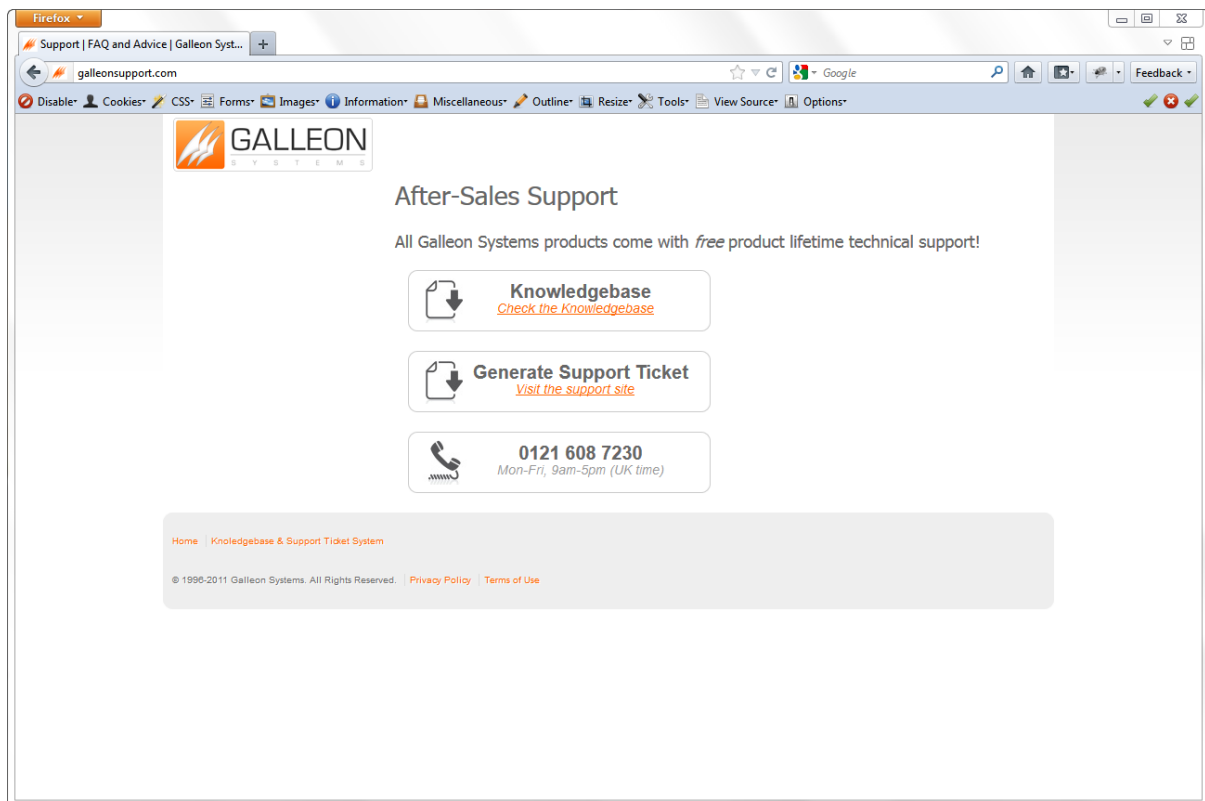

galleonsupport.com website with Knowledgebase and Support Ticket links.



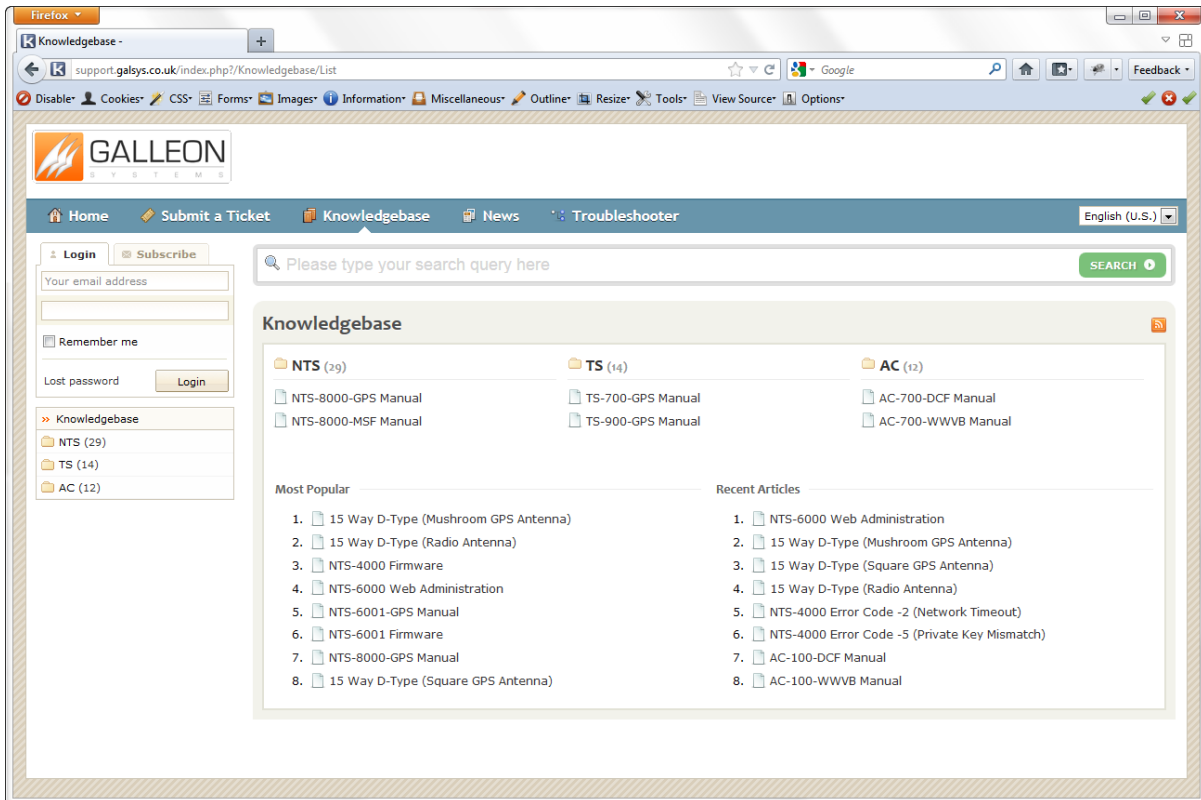

The Technical Support Knowledgebase.

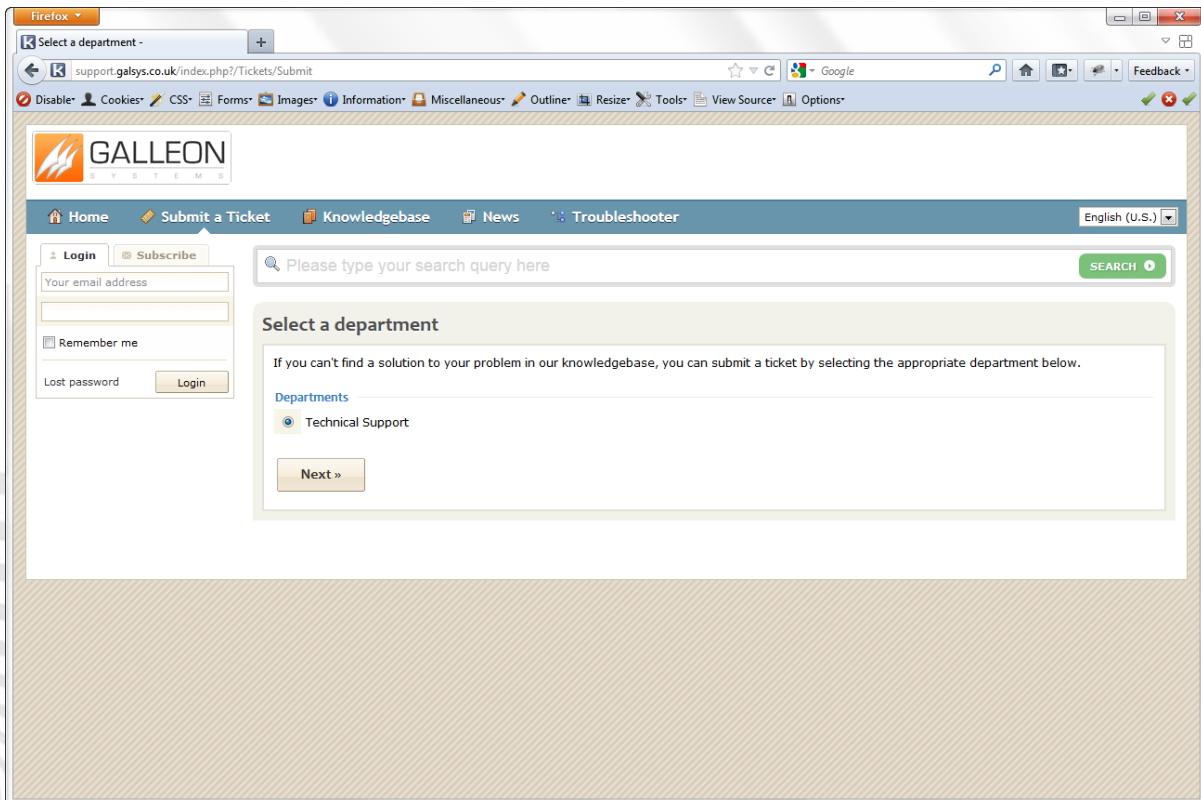

The Technical Support Ticket System.



NTS-6001

WARRANTY AND MAINTENANCE

WARRANTY

Galleon Systems warrants the time server to be free from defects in material and workmanship during a six-year period. The Warranty begins on the date the unit is shipped from Galleon Systems. Extended warranties are available by speaking to the Galleon Systems Sales Team.

Galleon Systems' liability under this Warranty is limited to repairing or replacing, at Galleon systems' option, the defective equipment and providing upgrade version changes for firmware. In case of repair, the product must be returned to Galleon systems.

This Warranty does not apply if repairs are required due to acts of nature beyond Galleon systems' control such as, but not limited to, lightning strikes, power surges, misuse, damage, neglect, or if repairs/modifications have been made or attempted by anyone other than personnel authorised by Galleon Systems.

In no event will Galleon Systems be liable for any indirect, special, incidental or consequential damages from the sale or use of this product.

This disclaimer applies both during and after the term of the warranty. Galleon Systems disclaims liability for any implied warranties, including implied warranties of merchantability and fitness for a specific purpose.

TECHNICAL SUPPORT, REPAIR AND RETURNS

To obtain any Technical Support with this product, contact Galleon Systems via the Support Website – galleonsupport.com

If throughout the Technical Support process it is deemed that you need to send any products back for repair, we will issue a Return Material Authorisation (RMA) Number and shipping instructions. Then ship the product, transportation prepaid, for inspection.

Typical Equipment repair or replacement time is five (5) business days, plus shipping times. One-way shipping is the customer's responsibility. Galleon Systems will return ship the equipment by the same means it was received.

Galleon Systems will not be responsible for unauthorised returns or for returns that do not list the RMA Number on a packing list attached in plain view on the outside of the shipping container.

